

LCD32

Thank you for having chosen an LAE electronic product. Before installing the instrument, please read this instruction booklet carefully in order to ensure maximum performance and safety.

1. INSTALLATION

1.1 The LCD32, size 169x38x78 mm (WxHxD), is inserted into the panel through a hole measuring 163x31.5 mm and is fixed by means of the screws on the rear flange. If fitted, check that the rubber gasket adheres to the panel perfectly, in order to prevent infiltration to the back of the instrument.

1.2 The instrument should work with room temperatures between -10°.. +50°C and relative humidity between 15%.. 80% inclusive. Supply voltage, switched powers and connection set-up should scrupulously comply with the indications given on the container. To reduce the effects of electromagnetic disturbance, keep the sensor and signal cables well separate from the power wires.

1.3 The sensor T1 measures the air temperature and activates in the thermostat control cycle; it should be placed inside the appliance in a point that truly represents the temperature of the stored product. The sensor T2 measures the evaporator temperature and should be place where there's the maximum formation of frost.

CAUTION: should the relays have to switch a heavy load frequently, it is advisable to contact the manufacturer for indications on the lifetime of the contacts.



Whenever products must be kept within very severe specifications or the products have considerable value, the use of a second instrument is recommended, which activates upon or warns of any malfunction.

2. OPERATING MODES

Upon switching on, just the central line (autotest) appears on the display for approximately three seconds and the subsequent indications depend on the operating status of the controller. Table 1 gives the indications associated with the various states.

OPERATING MODES LCD32					
STANDBY	NORMAL	INFO MENU	INFO DATA	SETUP MENU	PARAMETER VALUE
OFF Not Operating	-19 Product temp. (sim.)	T1 Air temperature	→ -20	SCL Display scale	→ 1°C
	DEF Defrost	T2 Evaporator temperature	→ -25	SPL Minimum setpoint	→ -25
	REC Recovery after alarm	THI Max stored temperature	→ -16	SPH Maximum setpoint	→ -18
	HI High temperature alarm	TLO Min. stored temperature	→ -19	...	→ ...
	...	CND Condenser clean cycle	→ 15	...	→ ...
	EI Faulty T1 probe	LOC Locked keypad	→ NO	...	→ ...

TABLE 1

2.1 STANDBY. The button  allows the LCD32 to be put on a standby, i.e. to exclude output control and the buttons with the exception of the light control (manual or through door). A permanent  indication on the display shows that the outputs are off.

2.2 NORMAL. During normal operation, the display shows the temperature measured by probe T1, handled by the microprocessor so that it's displayed in the most representative way. In other words, the parameter **SCL** is used to select the display in °C with auto-range (SCL=1°C), in °C with 1° fixed resolution (SCL=2°C) or in Fahrenheit (SCL=°F). The measured temperature may be corrected with a fixed offset by assigning a value other than 0 to the parameter **OSI**. Furthermore, prior to display, the temperature is treated by an algorithm that allows the simulation of a thermal mass directly proportional to the **SIM** value. The result is a reduction in the

fluctuation of the displayed value.

2.3 INFO MENU. Pressing the button I activates the information selection menu. From this menu you can display the instantaneous temperatures T1 and T2, the maximum (THI) and minimum (TLO) stored temperature, the operation time totalized by the condenser since its last cleaning (CND) and the keypad status (LOC). The information to be displayed can be selected sequentially, by pressing I repeatedly or quickly via the buttons V and A to scroll through the menu. Exit from the info menu is by pressing button I or automatic after 6 seconds of not using the keypad.

In the INFO operating mode it's also possible to reset the recordings THI and TLO and the hour counter CND by pressing buttons I + I simultaneously while the value is displayed.

2.4 KEYPAD LOCK. The keypad lock avoids undesired, potentially dangerous operations, which might be attempted when the controllers works in a public place. In the INFO mode, through the buttons V and A it's possible to assign YES or NO to the parameter **LOC**. With LOC=YES all keypad commands are inhibited.

2.5 DEFROSTING. By assigning a value greater than 0 to the parameter **DDY**, during defrost the indication DEF is displayed instead of the temperature. In this case, after defrost and for the time DDY programmed, the indication REC shows that the normal thermostatic cycle is resumed.

2.6 ALARM. An anomaly in the operation is displayed through the lighting up of an abbreviation showing its cause: HI / LO high/low alarm temperature in the cabinet, DO door open, HP condenser high pressure, CL periodic condenser cleaning, E1 / E2 fault of probe T1/T2.

2.7 SETUP. The setup is accessed by pressing the buttons V + I + A in succession and keeping them pressed simultaneously for 5 seconds. The available parameters appear in TABLE 2 as shown below.

3. CONFIGURATION

The controller is adapted to the controlled system by suitably programming the configuration parameters, that is, through the setup (see par. 2.7). The instrument is dispatched with a general setup and correctness of the parameters must therefore be checked before use. In the setup, press button A to pass from one parameter to the next, and press button V to go back. To display the value of a parameter press I , to modify it press buttons I + A or V simultaneously. Exit from the setup is by pressing button I or automatic after 30 seconds of not using the keypad. The setpoint **SP (IISP)** can be displayed and programmed even during normal operation of the controller, by pressing button I + A or V . The range in any case remains within the limits **SPL** and **SPH (IISL and IISH)**.

SCL	1°C/2°C/°F	Readout scale	ADO	0.. 30 [min]	Door alarm delay
SPL	-30.. SPH [°]	Minimum temperature set point	AHP	NON/ALR/STP	high pressure alarm operation
SPH	SPL.. +30 [°]	Maximum temperature set point	ACC	0.. 52 [weeks]	Periodic condenser cleaning
SP	SPL.. SPH [°]	Effective temperature set point	OAU	NON/0-1/LGT/ALR	Operating mode auxiliary output
HYS	+0.1.. +10.0 [°]	Thermostat hysteresis	LSM	NON/MAN/DOR	Light switching mode
CRT	0.. 30 [min]	Compressor rest time	IISM	NON/MAN/DI2	2nd set switching mode
CDC	0.. 10	Compressor regulation with sensor T1 failure	IISL	-30.. IISH [°]	Minimum 2nd temperature set
DFR	0.. 24	Defrosting frequency /24h	IISH	IISL.. +30 [°]	Maximum 2nd temperature set
DLI	-30.. +30 [°]	Defrost end temperature	IISP	IISL.. IISH [°]	Effective 2nd temperature set
DTO	1.. 120 [min]	Maximum defrosting duration	IHY	+0.1.. +10.0 [°]	Hysteresis of 2nd temperature set
DTY	FAN/ELE/GAS	Defrost type	IHF	0.. 24	Defrosting frequency /24h in mode 2
DRN	0.. 30 [min]	Drain down time	IIFT	YES/NO	Evaporator fan timed control in mode 2
DDY	0.. 60 [min]	Defrosting display control	T2	YES/NO	Probe T2 enabling
FDD	-30.. +30 [°]	Fan delay temperature	OS1	-12.. +12 [°]	Probe T1 offset
FTC	YES/NO	Evaporator fan timed control	OS2	-12.. +12 [°]	Probe T2 offset
ATL	-12.. 0 [°]	Low alarm differential	TLD	1.. 30 [min]	Delay for min./max. temperature storage
ATH	0.. +12 [°]	High alarm differential	SIM	0.. 100	Display slowdown
ATD	0.. 120 [min]	Alarm temperature delay	ADR	1.. 255	Peripheral address

TABLE 2

CAUTION: upon changing the display scale SCL, it is ABSOLUTELY necessary to reconfigure the parameters related to the absolute (SPL, SPH, SP, etc.) and differential (HYS, ATL, ATH, etc.) temperatures.

4. THERMOSTAT CONTROL

4.1 Thermostat control is based on comparing the temperature T1, the set point ***SP** and the hysteresis ***HYS**.

Example: SP= 2.0; HYS= 1.5, relay Off with T1= +2.0° and On with T1= +3.5° (2+1.5).

The compressor only switches On again if the minimum Off time **CRT** since the previous switchover has elapsed. Whenever a very small hysteresis HYS must be maintained, we advise assigning a suitable value to CRT in order to reduce the number of starts/hour.

4.2 If sensor T1 fails, the output is controlled for a fixed time established with CDC; this determines the activation time of the output

within 10-minute cycles.

Example: CDC=06, 6 minutes On, 4 minutes Off.

*Actual setpoint and hysteresis depend on the selection I/II: in mode I, the reference parameters are **SP** and **HYS** while in mode II, **IISP** and **IIHY**.

5. DEFROSTING

5.1 Defrosting starts automatically when the internal timer reaches the necessary time to obtain the defrosting frequency set with ***DFR**. For example, with DFR=4 defrosting occurs once every 6 hours. With DFR=0 the timed defrosting function is cut out. The internal timer is set to zero when the instrument is switched on and at each subsequent defrost start. When the controller is put on a standby, the timer count is "frozen" (is not incremented).

Defrosting may also be induced manually by keeping the button  pressed for 2 seconds.

During a High Pressure alarm (see par. 7.3), defrost is suspended.

5.2 Once defrost has started, the outputs are controlled according to parameter **DTY** as per the following table:

DTY	DEFROST	COMPRESSOR	FANS
FAN	Off	Off	On
ELE	On	Off	Off
GAS	On	On	Off

TABLE 3

5.3 Defrost lasts for the time **DTO** but, if the evaporator probe has been enabled (T2=YES) and temperature **DLI** is achieved before this time elapses, defrost will be terminated in advance.

Now, if **DRN** is greater than 0, before cooling starts all outputs will remain off for the time assigned to DRN. This phase, called drain down, will allow a complete ice melting and the drain of the resulting water.

* The actual defrost frequency depends on the selection I/II: in mode I, the reference parameter is **DFR** while in mode II it's **IIDF**.

6. EVAPORATOR FANS

6.1 During thermostatic control, the evaporator fans are controlled by parameter ***FTC**. With FTC=YES, the fans follow the compressor cycle: they always run together with the compressor and, when it stops, they switch on intermittently with fixed times of 20 seconds On and 40 seconds Off. Such function results in energy saving and internal humidity control.

With FTC=NO, the fans work all the time.

6.2 If the LCD32 is connected to a door switch, by assigning a value greater than 0 to **ADO**, you allow the fans to be stopped when the door is opened during thermostatic control. At the same time, a value greater than zero to ADO, enables compressor stop and door open alarm after the programmed time. With ADO=0 the door switch status is ignored.

6.3 After defrosting, if probe T2 is active (T2=YES), temperature **FDD** provides evaporator fan re-start. In other words, the fans re-start when the evaporator has a temperature lower than FDD. If such condition doesn't occur within 4 minutes following defrost termination, the fans will however be switched on again.



* The way the fans will be actually controlled depends on the selection I/II: in mode I they work according to **FTC**, while in mode II the fans work according to **IIFT**.

7. ALARMS

With LCD32, correct operation of the refrigerator and thermostat may be checked thanks to a wide range of functional and diagnostics alarms, individually selectable by means of the relevant activation parameters. The alarm warnings are given on the display through explicit indications (see following par.), intermittent buzzer sounding and, with **OAU=ALR**, even on the auxiliary relay (not for condenser cleaning). During an alarm, by keeping button  pressed for 2 seconds, the buzzer is muted. Then, if the alarm persists, the buzzer will be periodically switched on for 20 seconds every 60 minutes, until the alarm ends (the display indications and the relay remain on all the time). The repeated acoustic warning applies to all alarms with the exception of the condenser cleaning alarm. Operation of the various sections is given in detail below.

7.1 The parameters **ATL** and **ATH** define two differential temperatures that, referred to the set point, determine the temperature alarm thresholds. **ATL** establishes the alarm differential for temperatures below set point, **ATH** the alarm differential for temperatures above set point + hysteresis. Putting one or both differentials to 0 cuts out the corresponding alarm.

Example: SP= -20, HYS= 2.0, ATL= -5.0, ATH= 05.0; the alarm thresholds are set at -25° (-20-5) and -13° (-20+2+5).

The alarm warning may be immediate or delayed by the time **ATD** whenever this is greater than 0. The indication  for high temperature and  for low temperature alarm blinks on the display. The alarm indication remains stored in the display, even when the alarm is over, until you acknowledge the alarm manually by means of the button .

The high temperature alarm is bypassed during defrosting.

7.2 If at the suitable controller input a switch is connected to detect the door status, by assigning a value greater than 0 to the

parameter **ADO**, you enable an open door alarm function.

In this way, if the door remains open for at least the time programmed with ADO, the controller will detect an abnormal condition and will react by stopping the compressor and displays the alarm source through the blinking indication .

7.3 If the condensing unit is fitted with a contact for High Pressure warning, you can connect that contact to the digital input DI2 and assign ALR or STP to the parameter **AHP**, depending on how you wish the controller to operate when the contact is opened. With AHP=ALR the controller will only get the alarm to be signalled by means of the buzzer and the blinking indication  on the display. Differently, with AHP=STP, when the contact is opened the alarm is signalled, the compressor stops immediately and defrosts will be suspended.

With AHP=NON, all functions related to the High Pressure alarm are inhibited.

7.4 Assigning a value greater than 0 to the parameter **ACC** enables the indication for periodic cleaning of the condenser. In other words, when the count of compressor hours of operation reaches the equivalent in weeks set with ACC, an indication for cleaning appears on the display.

*Example: with ACC=16 there is a warning once every $16 \times 7(\text{weeks}) \times 24(\text{hours}) = 2688$ hours of **compressor operation**, in other words, assuming for this an operation with 5 minutes On and 5 minutes Off - after approx. 32 weeks.*

In order to clear the time counter, please proceed as described at paragraph 2.3.

7.5 Failure of probe T1 or, if enabled, probe T2, are signalled with the blinking indication  or  respectively.

8. TEMPERATURE STORAGE

The LCD32 features a system for permanent storage of the minimum and maximum temperature logged during operation. This system is a valid help to achieve compliance with the HACCP directive in its part relating to a correct preservation of foodstuffs. Temperature is measured by probe T1 which should therefore be placed in a point where the temperature of the preserved product may always be measured correctly. The logging is however subject to some simple rules that filter the data and give a rational interpretation. As a matter of fact, the logging is suspended during the periods in which the refrigerator is put on a standby and during defrostings and, during the normal operation (thermostatic control), it's "slowed down" through the parameter **TLD**. This parameter defines the time during which the measured temperature must permanently exceed the current value before the logging is performed. In this way, it will be possible to avoid idle loggings that don't reflect the actual product temperature, because of, for example, the door being left open, the temperature recovery after a defrost or other temporary short term temperature huntings.

We therefore advise you to program a reasonably long TLD time, for instance 5-15 minutes, to put the product into the refrigerator and now start a new logging cycle by clearing previous values (see par. 2.3). It will now suffice that at regular intervals, in the INFO menu you check the minimum and maximum logged values in order to know if the product has been kept within the limits established by the criteria of a correct preservation.

9. AUXILIARY FUNCTIONS

In addition to the basic functions described above, the LCD32 features a series of auxiliary functions that, thanks to the configuration parameters, give the controller great flexibility to meet a wide range of standard and non standard configurations, in the field of commercial refrigeration.

9.1 The controller comprises an auxiliary output on relay that, through the parameter **OAU**, can be associated to the standby function (OAU=0-1) to control switched loads following the On and Standby status of the controller. As other options, the same output may be associated to light control (OAU=LGT) or alarm control (OAU=ALR) or, finally, disabled permanently (OAU=NON).

9.2 If the auxiliary output is destined to light control (OAU=LGT), the ways this is controlled are defined by the parameter **LSM**. With LSM=MAN the lights are controlled manually through the button ; with LSM=DOR the lights are controlled via the door switch and, finally, with LSM=NON this function is disabled.

9.3 The LCD32 offers an innovative feature to enhance the performance of the refrigerator. Infact, you can select the control parameters between two different pre-programmed groups, in order for the fundamental control parameters to be adapted quickly to changing needs such as, for example: High/Low Temperature range change, stored product change (meat, fish, vegetables ...), maximum cooling capacity or energy saving. The parameters switched over in mode **I** and **II** are: **SPL, SPH, SP, HYS, DFR, FTC** and **IISL, IISH, IISP, IIHY, IIDF, IIPT**.

With the parameter **IISM** you select if the changeover from group **I** to group **II** is made via the button  (IISM=MAN), through input DI2 (IISM=DI2) or inhibited (IISM=NON).

The activation of group II is signalled by the lighting up of the suitable LED on the controller front.

9.4 The controller is provided with a serial port for connection to a PC or a programmer. In the first case it is important to assign to the parameter **ADR** a different value for each linked unit (peripheral address); with automatic programming, ADR should remain on 1.

WARRANTY

LAE electronic Srl guarantees its products against defects due to faulty materials or workmanship for one (1) year from the date of manufacture shown on the container. The Company shall only repair or replace products which are shown to be defective to the satisfaction of its own technical services. The Company shall not be under any liability and gives no warranty in the event of defects due to exceptional conditions of use, misuse or tampering.

All carriage expenses for returning the product to the manufacturer, after having obtained the latter's permission, and for any return to the buyer shall be paid by the buyer.

WIRING DIAGRAM

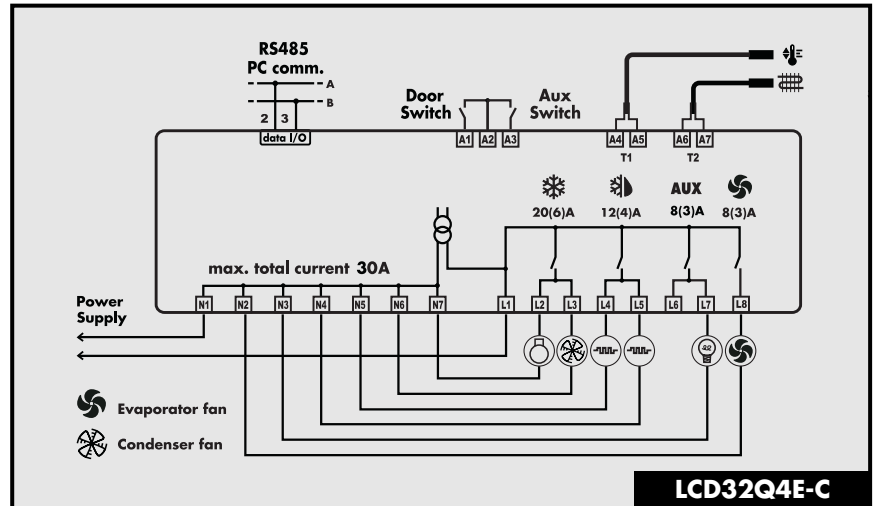

PARTNER VENEZIA • 041 5460713